

ReSound

rediscover hearing

USER GUIDE



MINI BTE 60
BTE 61
BTE 70
BTE 71
BTE 80
BTE 90

RESOUND BEHIND-THE-EAR PERSONAL HEARING SYSTEM

Congratulations on the purchase of your new fully-digital ReSound hearing instrument!

This booklet describes the functionality of BTE (Behind-The-Ear) models in the ReSound product line.

The functionality depends on the model; your hearing care professional will highlight the features of your particular hearing instrument.

ReSound's advanced technology and customized programmes, selected by your hearing care professional, will bring the best possible hearing solution to your family life, and your professional and social activities.

Your hearing instrument has been adjusted to your individual hearing loss. Please familiarize yourself with the information in this booklet. Proper understanding and use of your new ReSound hearing instrument will allow you to derive maximum hearing benefit.

This instruction covers the following ReSound BTE products: MINI BTE 60, MINI BTE 61, BTE 70, BTE 71, BTE 80 and BTE 90

Your hearing instrument is model:

Serial No L: _____

Serial No R: _____

ReSound is a registered trade mark of GN ReSound A/S

Contents

page

Your ReSound BTE Hearing Instrument	4
Your ReSound Mini BTE Hearing Instrument	4
Programme Selector	6
Your Programme Environments	7
Directionality	7
Stand-by Function	7
On/Off Function	8
SmartStart	8
Volume Control	9
Direct Audio Input (DAI)	10
Inserting and removing the Instrument	11
Low Battery Warning	13
Changing the Battery	14
Battery Warning Information	15
Daily Maintenance	16
Cleaning the Ear Mould and replacing Sound Outlet Filter	17
Telephone Use	22
Using Assistive Listening Systems	23
Repairs	23
Troubleshooting Guide	24
General Precautions	26
Technical Data	27
Key Word Index	29

Your ReSound BTE Hearing Instruments

- 1. Programme Selector
- 2. Battery Compartment & On/Off Switch
- 3. Sound Outlet
- 4. 1st Microphone Sound Inlet
- 5. 2nd Microphone Sound Inlet
- 6. Volume Control (optional)
- 7. Direct Audio Input (DAI) (optional)

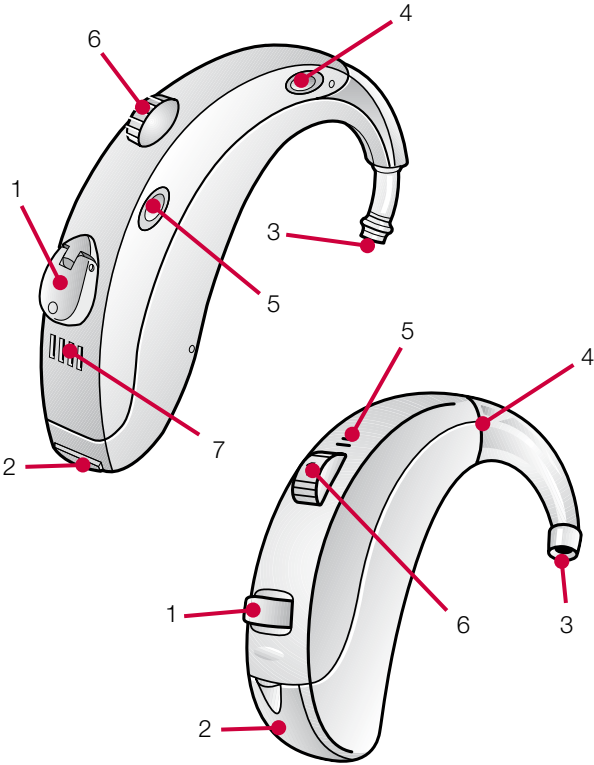

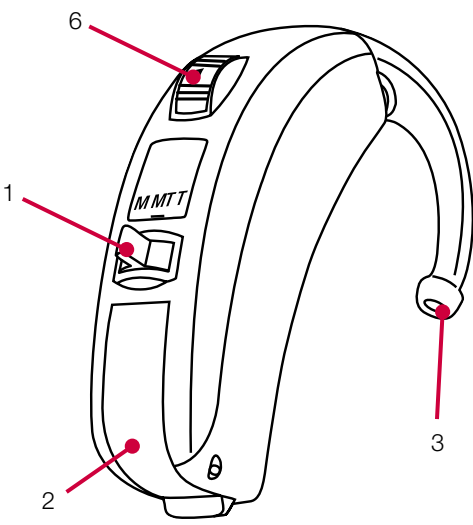
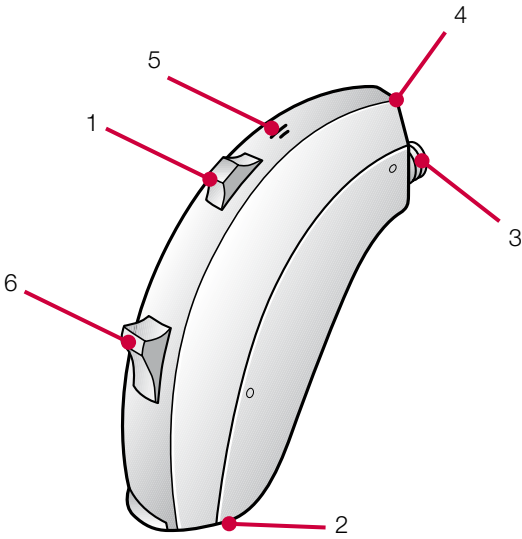

- 8. Left/Right indicator
(Right=Red, Left=Blue)
- 9. Battery lock
- 10. Model
- 11. Manufacturer

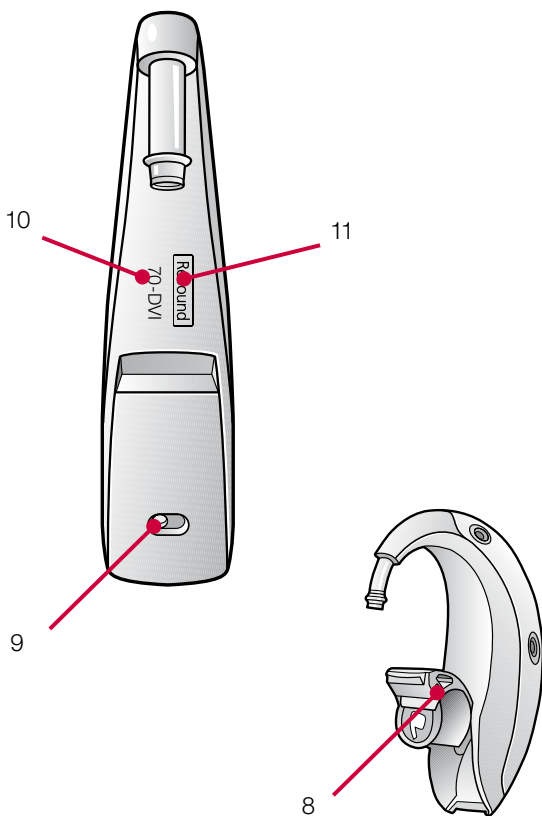

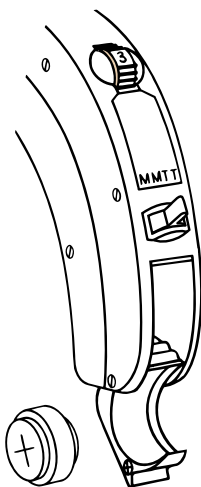
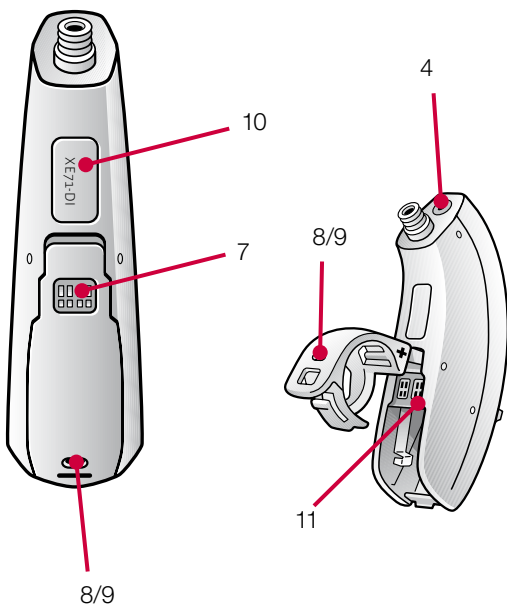

Your ReSound mini 60 Hearing Instrument

- 1. Programme Selector
- 2. Battery Compartment & On/Off Switch
- 3. Sound Outlet
- 4. 1st Microphone Sound Inlet
- 5. 2nd Microphone Sound Inlet
- 6. Volume Control
- 7. Left/Right indicator (Right=Red, Left=Blue)
- 8. Battery lock
- 9. Model
- 10. Manufacturer

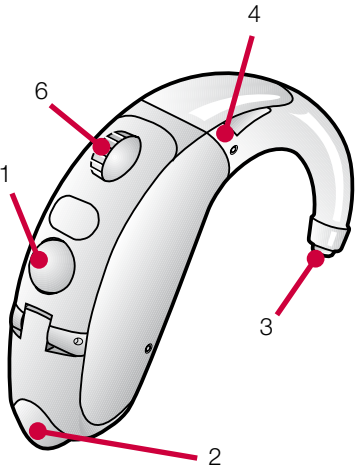
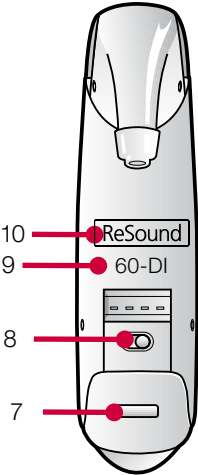
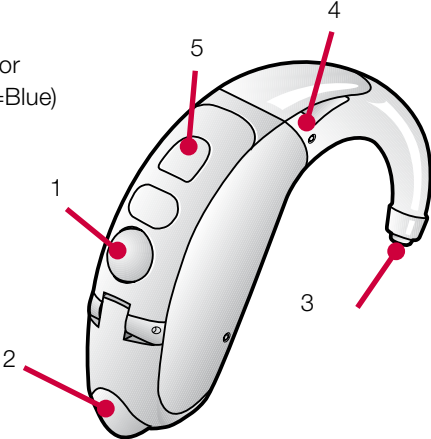

Your ReSound mini 60 Thin Tube Hearing Instrument

- 1. Programme Selector
- 2. Battery Compartment & On/Off Switch
- 3. Thin Tube Adaptor
- 4. 1st Microphone Sound Inlet
- 5. 2nd Microphone Sound Inlet
- 6. Thin Tube with standard dome
- 7. Volume Control
- 8. Left/Right indicator (Right=Red, Left=Blue)
- 9. Battery lock
- 10. Model
- 11. Manufacturer

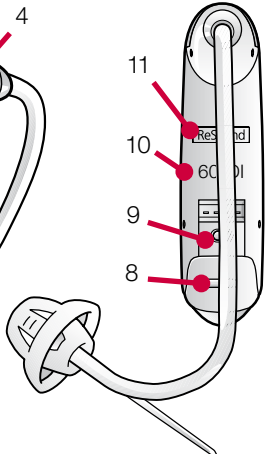
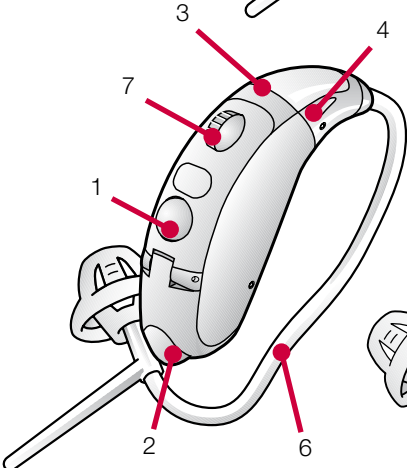
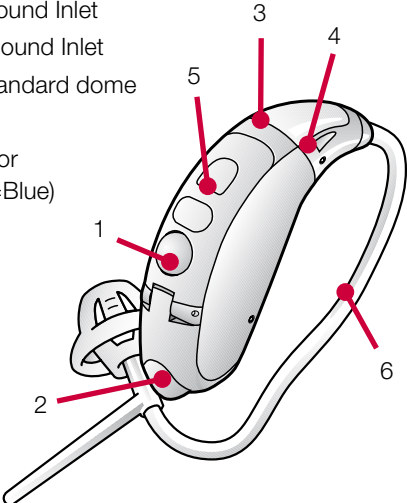

Programme Selector

Your hearing care professional has most likely programmed multiple programmes into your instrument. You can select programmes simply by depressing the programme selector once. You will then hear one or more “beeps”, indicating which programme you have selected. Your hearing instrument will switch programmes as follows:

Examples:

4 programmes: 1 → 2, 2 → 3, 3 → 4, 4 → 1

With optional telecoil: 1 → 2, 2 → 3, 3 → T, T → 1

With Direct Audio Input: 1 → 2, 2 → 3, 3 → DAI, DAI → 1

You can always return to programme 1 by turning your instrument off and then on again or by placing it in stand-by mode and then returning to its operating mode.

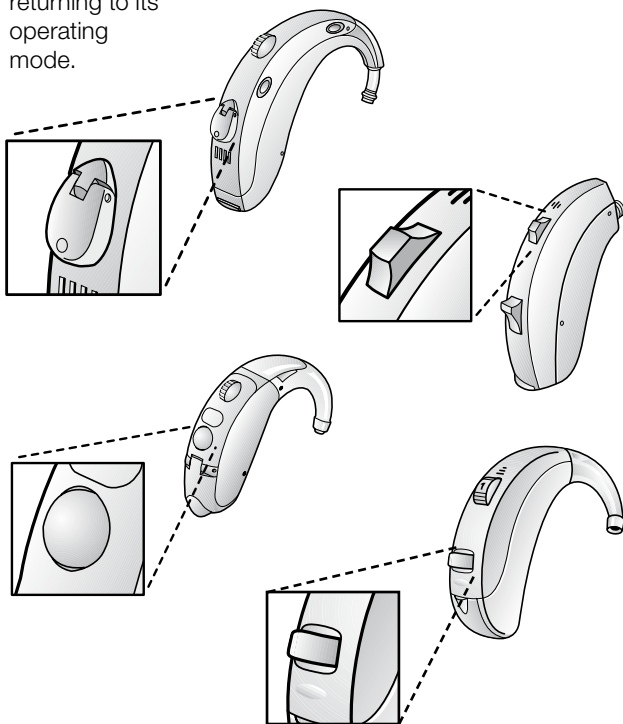

Your Programme Environmentst

Programme	Description of when to use

Telecoil

See section “Telephone Use” for a detailed description of this function. ReSound Metrix BTE instruments are all equipped with a telecoil in their standard version.

Directionality

The ReSound instrument is equipped with two microphones and thus offers adaptive directionality. That is a function which enables better speech understanding in noisy situations. This function focuses on speech in front of you while sounds coming from the back or the side are suppressed. Directionality is available as an option in the custom programmes. The ReSound instrument furthermore offers SoftSwitching™. When SoftSwitching is turned on, the instrument automatically switches to adaptive directionality when you have a conversation in a noisy environment. Please ask your hearing care professional about this automatic feature.

Stand-by Function

To put the instrument into stand-by mode, hold down the programme selector for 5 seconds. You will hear a series of beeps, and the device is now in stand-by mode. Before returning to functional mode, you will need to wait approximately 5 seconds. After waiting, press the programme selector down once. Please note that the instrument is using a small amount of power when it is in stand-by mode.

On/Off Function

Your ReSound BTE is equipped with an on/off switch integrated into the battery compartment. When the battery compartment is fully closed, the instrument is turned on in its functional mode and programme 1 will be activated. Partially open the battery door until it snaps into the off-position. The instrument is then switched off. Whenever you are not wearing the instrument, remember to turn it off to reduce battery consumption.

SmartStart

SmartStart allows you to insert the instrument in the ear without annoying sounds like squealing. It delays the switch on time 10 seconds after closing the battery compartment, and is indicated by a beep every second after closing the battery compartment.

Volume Control

The ReSound models 60-VI, 70DV, 70DVI and 80-DVI offer a volume control allowing you to turn the volume up and down. When wearing the instrument, you can increase the volume by turning the volume control wheel up, and reduce volume by turning it down.

For each volume step, you will hear a “beep” signal indicating the change. If you reach the upper or lower limit of the volume control range, there will be a different type of “beep” signal with a lower pitch.

Please note that your instrument has been fitted by your hearing care professional and that your hearing loss has required a certain amount of amplification. This means that you may not be able to increase the volume as much as you can decrease it.

Volume Control

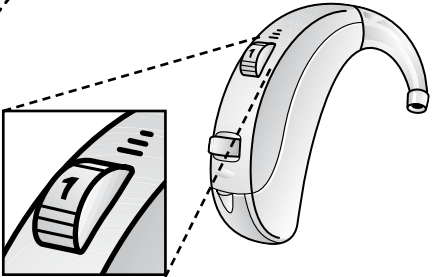
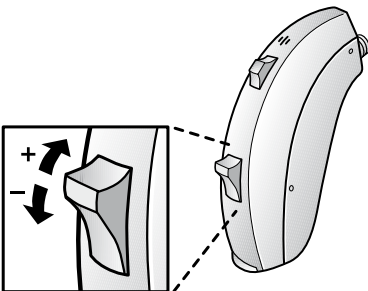
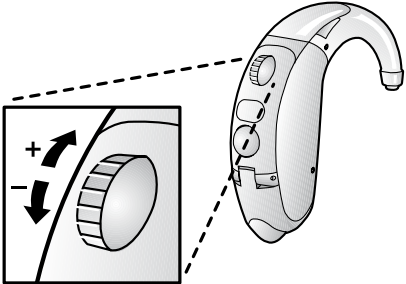
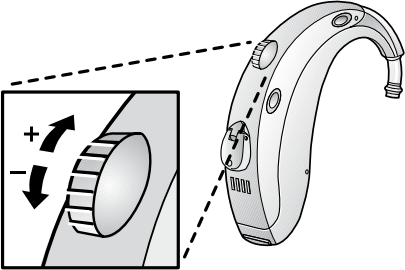

Direct Audio Input (DAI)

The ReSound mini BTE and BTE models 70-DI, 70-DVI and 80-DVI offer you the possibility of direct, undisturbed connection to facilities such as television, radio and remote microphone via the Direct Audio Input socket. Often, this will improve sound quality. The sound source is connected to your instrument with a cable or a wireless FM system to the audio shoe. The audio shoe will connect with a “click” to the hearing instrument and switch to Direct Audio Input automatically.

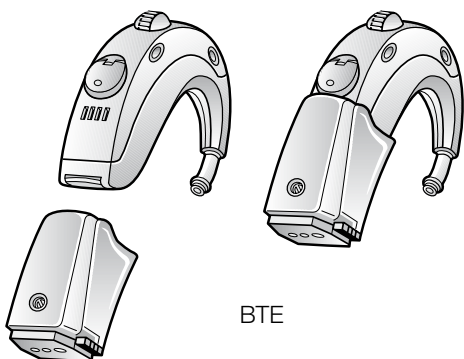

BTE

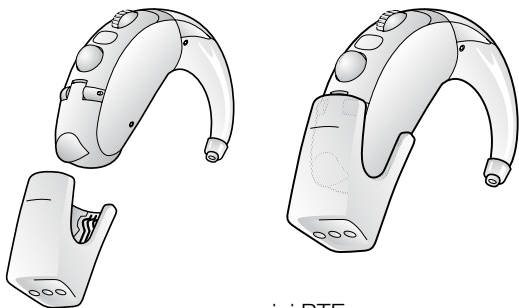

mini BTE

Direct Audio Input (DAI) - 61 and 71

Using the Direct Audio Input socket enables direct, undisturbed connection to facilities such as: Television - Radio - Remote microphone.

How to connect the Audio boot to the hearing instrument:
Pay close attention to the illustrations on how to connect and disconnect the audio boot below

1. Make sure the tip of the audio boot is placed firstly in the HAI (Hearing Instrument Accessories Interface).
2. Click the audio boot on to the hearing instrument.
3. The Audio boot is now connected.

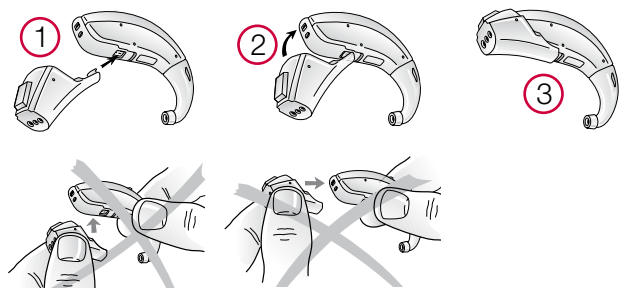

How to disconnect the Audio boot:

Important: Do not disconnect the audio boot without pushing the release button first.

4. Push the release button on the front side of the Audio boot.
5. Gently remove the Audio boot.

The sound source is connected to your instrument with a cable or a wireless FM system to the audio boot. The audio boot will connect with a “click” to the hearing instrument and switch to Direct Audio Input automatically.



Inserting and removing the instrument (- with ear mould)

Inserting the instrument

- With the battery door opened in the off position take the ear mould between thumb and index finger and position its 'point' in your ear canal. Now, slide the ear mould all the way into your ear with a gentle, twisting movement. Insertion can be easier if you gently pull your auricle backwards with your other hand.

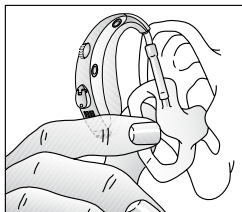

- Turn the top-part of the ear mould gently backwards and forwards so that it fits behind the fold of skin above your ear canal.

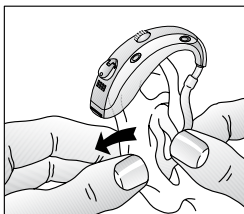

- Place the hearing instrument behind your ear. Move the ear mould up and down and press gently to ensure it is positioned correctly in the ear. Opening and closing your mouth can ease insertion. You will feel when the ear mould is positioned correctly.

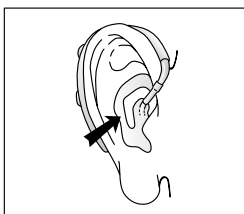

- When correctly positioned switch on your instrument by closing the battery door.

Inserting and removing the instrument (with FlexTubeThin Tube)

Inserting the instrument

- Hang the instrument over the top of the ear.

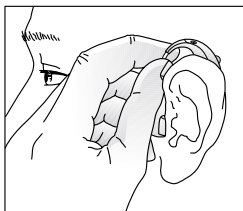

- Grasp the FlexTube/Thin Tube where it bends and push the dome into your ear canal. The dome should be placed far enough into the ear that the sound tube lies flush with your head. When the dome is placed appropriately, you should not see the FlexTube/Thin Tube sticking out when you look directly into a mirror.

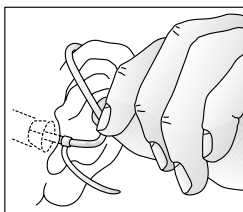

- If the device whistles, the most likely reason is that the dome is not placed correctly in the ear canal.

Other reasons can be buildup of earwax in the ear canal, or that the sound tube connection to the instrument has become loose, in which case the sound tube must be changed. It is also possible that the instrument settings are not optimal. If you have ruled out other reasons for the instrument squealing, it is recommended to contact your hearing care professional.

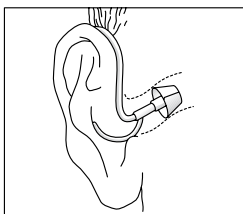

Changing the Battery

Open the battery compartment by turning the instrument off, and then using your fingernail to open it completely. After removing the old battery, insert the new one with the “+” (flat) side facing the “+” on the battery door. It should fit in like a puzzle piece. The battery door should close very easily. Never use force to close the door as this may damage your hearing instrument.

Always use a Zinc-Air battery. Please note that if the battery is weak, the hearing instrument performance will be reduced. Removing the battery when you are not wearing the instrument will help prevent corrosion of the battery contacts.

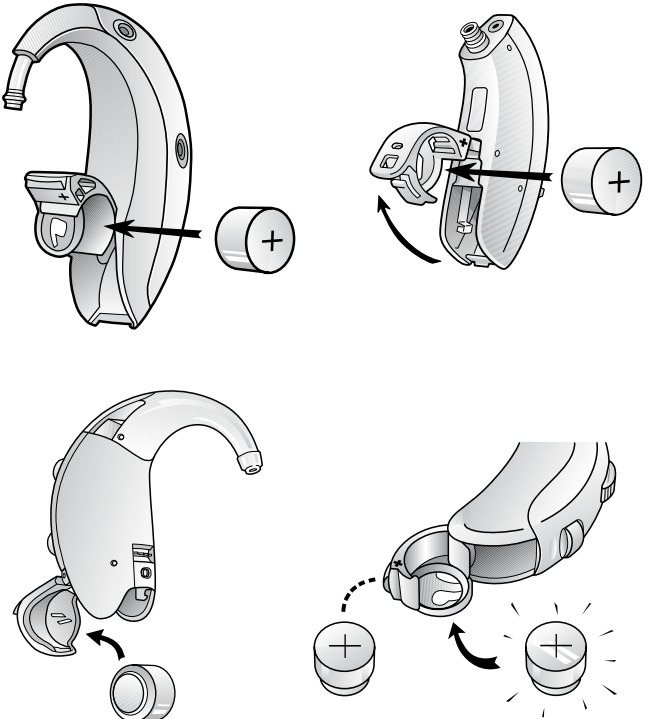

Battery Warning Information

Batteries contain dangerous substances and should be disposed of carefully in the interest of your safety and for the environment.

- Do NOT attempt to recharge batteries which are not specifically designated rechargeable as they may leak or explode.
- Do NOT attempt to dispose of batteries by burning them.
- Keep batteries away from small children and pets.
- Do NOT place batteries in your mouth.

If swallowed, see a physician immediately.

Daily Maintenance

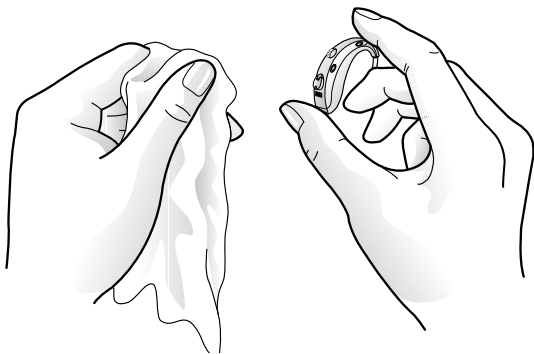

Keep your hearing instrument clean and dry. Wipe the case with a soft cloth or tissue after use to remove grease or moisture. If the instrument has been exposed to high humidity or perspiration, enclose it (with the ear mould) in a sealed container together with a drying agent (dessicator) overnight. Consult your hearing care professional concerning which drying agent to use.

To avoid the need for unwarranted repairs:

- Never immerse the instrument in water or other liquids since this may cause permanent damage to the circuitry.
- Protect your hearing instrument from rough handling, and avoid dropping it on hard surfaces or floors.
- Do not leave the instrument in or near direct heat or sunlight since excessive heat can damage the instrument or deform the casing.

Cleaning the Ear Mould and replacing Sound Outlet Filter

The ear mould should be cleaned regularly. Remove the ear mould and the silicone tubing from the hearing instrument before you clean it. Lukewarm water should be enough to clean wax off the ear mould. If ear wax is stuck in the sound canal of the ear mould, the cleaning loop or a syringe with lukewarm water can easily be used to “push” the wax out. Be sure to thoroughly dry the ear mould and its tubing before reconnecting it to the hearing instrument. Blow gently through the tubing to remove moisture trapped inside.

The silicone tubing connecting the ear mould to the hearing instrument should be changed if it becomes stiff or brittle.

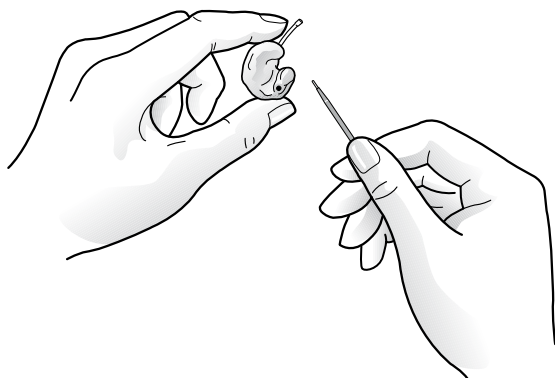

Sound Outlet Filter

Your ReSound hearing instrument is equipped with a filter.

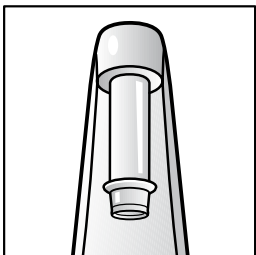

This filter is located at the top of the sound outlet and prevents moisture and debris from getting into the hearing instrument. If the hearing instrument seems to have lost power and changing the battery does not help, the filter may be blocked, and needs to be changed. See instructions below:

How to remove filter

Place the hook of the instrument into the long groove of the filter stick. Pull down and the filter will be removed.

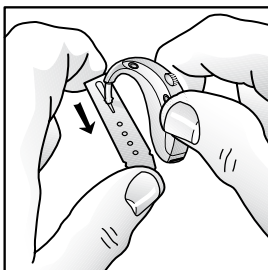

How to place filter on hook

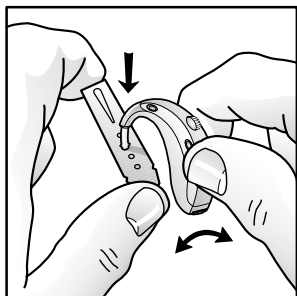

Place the hook on one filter and push gently. Rock the hook back and forth until the filter is released.

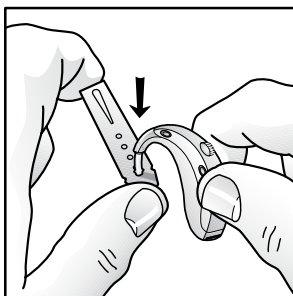

Now take the hook with the filter attached and press it in the hole at the end of the filter. The filter will now be fastened.

Cleaning the FlexTube/Thin Tube and dome

The FlexTube/Thin Tube feeds the amplified sound from the hearing instrument into the ear. It is important that the FlexTube/Thin Tube and the dome fit correctly into your ear. If the FlexTube/Thin Tube or the dome irritate your ear in any way and prevent you from wearing your hearing instrument, please contact your hearing care professional. You should never attempt to modify the shape of the FlexTube/Thin Tube yourself.

The FlexTube/Thin Tube and the dome should be cleaned regularly. Remove the FlexTube/Thin Tube from the instrument before cleaning by unscrewing it. Use a damp cloth to clean the FlexTube/Thin Tube and dome on the outside and use the black cleaning rod to “push” any debris out of the FlexTube/Thin Tube.

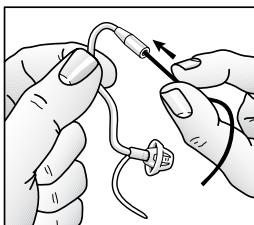

The cleaning rod should be inserted where the FlexTube/Thin Tube attaches to the instrument and pushed all the way through the sound tube and out through the dome. It is not recommended to submerge or rinse the FlexTube/Thin Tube and dome with water, as there is a risk that a water drop may become lodged in the FlexTube/Thin Tube. If this should occur, it will prevent sound coming through the FlexTube/Thin Tube, and may be harmful for the instrument's electronics.

The FlexTube/Thin Tube and dome should be changed every third month or sooner if the FlexTube/Thin Tube becomes stiff or brittle. We recommend that you have your hearing care professional change the dome for you. If your hearing care professional instructs you to change the domes yourself, make sure that they are securely fastened to the sound tube before inserting them in your ear. A failure to change the domes in accordance with the instructions could result in injury.

How to Mount the Standard Dome

We recommend that your hearing care professional changes the dome for you, since failure to change the domes in accordance with the instructions could result in injury. If you choose to change the dome yourself:

1. Push the dome over the grooves on the tube to mount it (1) + (2)
2. Make sure that it is securely fastened

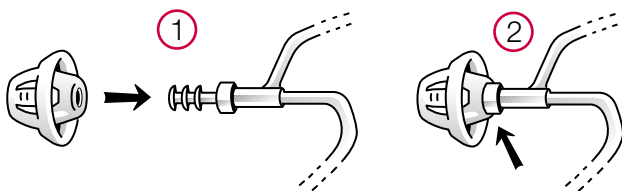

How to mount the Tulip-Dome

(1) + (2) The Tulip-Dome is mounted on the FlexTube/Thin Tube by pushing it over the grooves on the FlexTube/Thin tube.

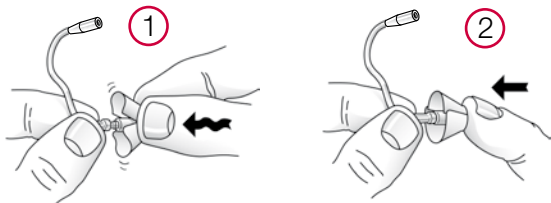

The Tulip-Dome should be directed with the sound outlet hole facing either down towards your shoulders or up towards your hair. (3) The sound outlet hole can turn both ways; the direction of the sound outlet hole affects the length of the sound tube according to the entrance of your ear canal. Please ask your hearing care professional which way the sound outlet hole should turn in your ear.

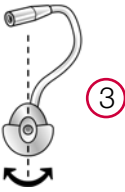

The Tulip-Dome consists of two “leaves” and it is important that the largest “leaf” is the outermost “leaf” (4). This can easily be done by pushing the “leaves” away from the FlexTube with your forefinger and middle finger (5). This will make the large “leaf” bend forward. Then you push it back and it will be placed on top of the smaller “leaf” (6). Now the Tulip-Dome is ready for insertion (7).

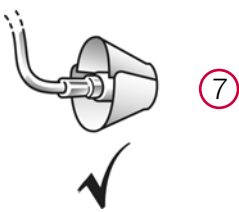
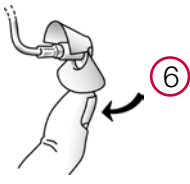
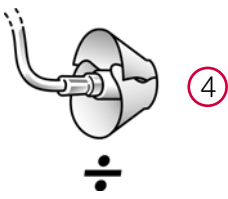

Telephone Use

Your hearing instrument is equipped with an induction coil (telecoil) which picks up magnetic emanations from a hearing instrument compatible telephone. Your hearing care professional can activate the telecoil. By selecting the telecoil programme, the hearing instrument will only pick up the sounds coming from the telephone.

When using the telecoil programme, the receiver of the telephone should be held as shown in the drawing. You may need to move the handset around slightly to find the best reception.

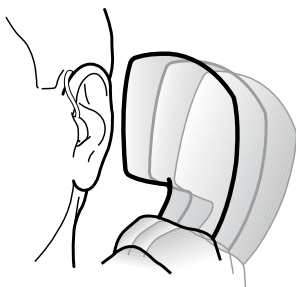

If you do not wish to have a telecoil programme, you may still use the phone while wearing your hearing instrument. Many hearing instruments will whistle (feedback) when in close proximity to a telephone. To reduce the potential for this problem, your hearing instrument is equipped with an adaptive digital feedback suppression (Dual Stabilizer DFS) system which allows for use of the telephone while greatly reducing the chance of feedback. Hold the phone close to the top microphone of the hearing instrument, but not directly on it. If there is feedback, it may take a few seconds for the instrument to adapt.

Using the telephone, while wearing your hearing instrument, may require some practice.

Using Assistive Listening (tele-loop) Systems

Many gathering places are equipped with assistive listening (tele-loop) systems, e.g. in schools, theatres and houses of worship. To take advantage of a tele-loop system, select the telecoil programme. When the telecoil programme has been selected, you will be able to hear a clean sound signal via the tele-loop system. If the instrument goes dead in the telecoil programme, this may be because the loop system is not operating. If a school, theater or house of worship does not have a tele-loop system, try and sit as close as possible to the front and use one of the microphone programmes.

Repairs

If your ReSound hearing instrument malfunctions, it must be repaired by a qualified technician. Do not attempt to open the case of the hearing instrument since this would invalidate the warranty. If your ReSound hearing instrument requires service, please contact your hearing care professional for assistance.

TROUBLESHOOTING GUIDE

SYMPTOM	CAUSE
No sound	<ul style="list-style-type: none">• Not turned on• Dead battery• Battery improperly inserted• Blocked ear mould or tube• Blocked sound outlet filter
Not loud enough	<ul style="list-style-type: none">• Loose ear mould• Blocked ear mould or dome• Change in hearing• Excessive ear wax• Blocked sound outlet filter • Volume set too low
Whistles	<ul style="list-style-type: none">• Loose ear mould• DFS needs re-initialization
Sound not clear or distorted	<ul style="list-style-type: none">• Weak battery• Poorly fitting ear mould or dome• Hearing instrument damaged• Hearing instrument settings not optimal

If there are any other problems not mentioned in this guide, please contact your hearing care professional.

POSSIBLE REMEDY

- Turn on
- Replace battery
- Insert battery properly
- Clean ear mould or tube blockage
- Change filter or consult your hearing care professional

- Reinsert carefully
- Clean ear mould or dome
- Consult your hearing care professional
- Consult your physician
- Change filter or consult your hearing care professional
- Consult your hearing care professional

- Remove and reinsert
- Consult your hearing care professional

- Replace battery
- Consult your hearing care professional
- Consult your hearing care professional
- Consult your hearing care professional

General Precautions

- Consult a physician if you find a foreign object in your ear canal, if you experience skin irritation or if excessive ear wax accumulates with the use of the hearing instrument.
- Different types of radiation, e.g. from NMR, MRI or CT scanners, may damage the hearing instrument. Therefore, do not wear the hearing instrument during these or other corresponding scanning procedures. Other types of radiation (burglar alarms, room surveillance systems, radio equipment, mobile telephones, etc) contain less energy and will not damage the hearing instrument. They could however momentarily affect the sound quality or create strange sounds from the hearing instruments.
- Warning: Do not wear the hearing instrument in mines or other explosive areas, unless those areas are certified for hearing instrument use.
- Warning to hearing care practitioners
Special care should be exercised in selecting and fitting hearing instrument(s) whose maximum sound pressure level exceeds 132 dB SPL with an IEC 60711: 1981 occluded ear simulator, because there may be a risk of impairing the remaining hearing of the hearing instrument user.

Technical Data

Maximum Output (2cc Coupler / IEC 60118-7)

60-DI	126 dB SPL (Typical)
60-DI Thin Tube	127 dB SPL (Typical)
60-VI	126 dB SPL (Typical)
60-VI Thin Tube	127 dB SPL (Typical)
61-DI Classic	132 dB SPL (Typical)
61-DI Thin Tube	123 dB SPL (Typical)
70-D	127 dB SPL (Typical)
70-DI	127 dB SPL (Typical)
70-DV	127 dB SPL (Typical)
70-DVI	127 dB SPL (Typical)
71-DVI - Classic/open	126 dB SPL (Typical)
71-DVI - Thin Tube	129 dB SPL (Typical)
80-DVI	135 dB SPL (Typical)
90	142 dB SPL (Typical)
ES70 open	118 dB SPL (Typical)
ES70-VI	124 dB SPL (Typical)
ES70-DVI	124 dB SPL (Typical)
ES80-VI	137 dB SPL (Typical)
ES80-DVI	137 dB SPL (Typical)

Key Word Index

Assistive listening (tele-loop) systems	23
Battery change	14
Battery compartment	4,8,14
Cerumen/earwax	17
Cleaning the instrument	16,17
Directionality	7
Direct audio input (DAI)	10
Ear Mould / Dome	17,19,20,21
Environmental programmes	7
Low battery warning	13
Maintenance	16
On/off switch	4,8
Programme Selector	4,6
SmartStart	8
Sound outlet filter	18
Stand-by mode	7
Technical data	27
Telecoil use	6,7,22,23
Telephone use	22
Troubleshooting guide	24-25
User operated controls	4,6,7,8,9
Volume control	9

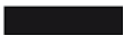

Please ask your local hearing care professional concerning disposal of your hearing instrument

ReSound

rediscover hearing

Worldwide Headquarters

GN ReSound A/S
Lautrupbjerg 9
DK-2750 Ballerup, Denmark
Tel.: +45 45 75 11 11
Fax: +45 45 75 11 19
www.gnresound-group.com

United Kingdom

GN ReSound Ltd.
1 Landscape Close
Weston Business Park
Weston-on-the-Green
Oxon OX25 3SX
Tel.: 0 1869 343 500
Fax: 0 1869 343 466
www.gnresound.co.uk

Australia

GN ReSound Pty. Ltd.
Unit R1 Regent Park Estate
391 Park Road
Regent Park NSW 2143
Tel.: 02 9743 9707
Fax: 02 9743 7472
www.gnresound.com.au

New Zealand

GN ReSound (NZ) Ltd.
12 Parkway Drive
Mairangi Bay
Auckland
Tel.: (free) 0800 900 126
Fax: (free) 0800 007 695
www.gnresound.co.nz

Any issues relating to the EU
Medical Device Directive 93/42/EEC
should be directed to GN ReSound A/S

